

TECWARE

$\alpha$  Alpha<sup>M</sup>

Quick Start Guide

# Contents

◆ Specification .....	p.01
◆ Panel Removal .....	p.02
◆ Front Panel I/O Connections .....	p.03
◆ Component List .....	p.04
◆ Motherboard Installations .....	p.06
◆ SSD Installation .....	p.07
◆ GPU & PSU Installation .....	p.08
◆ Cable Management Area .....	p.09
◆ CPU Cooler / Fan Installation .....	p.10
◆ Package Contents & Warranty .....	p.11

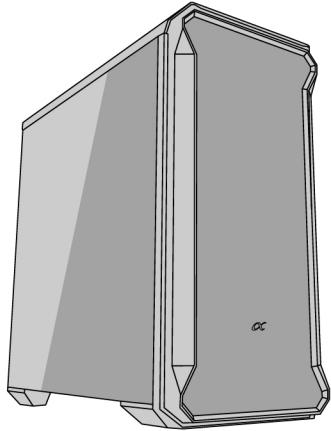

## Specifications

Type	Specification
Motherboard Support	mATX, mITX
Dimensions	430(L) x 210(W) x 430(H) mm
3.5" HDD Drive Bay	up to 2
2.5" SSD Drive Bay	up to 3
Expansion Slots	4
Maximum GPU Length	375mm
Cable Management	22 mm
Maximum CPU Cooler Height	up to 160mm

## Panel Removal

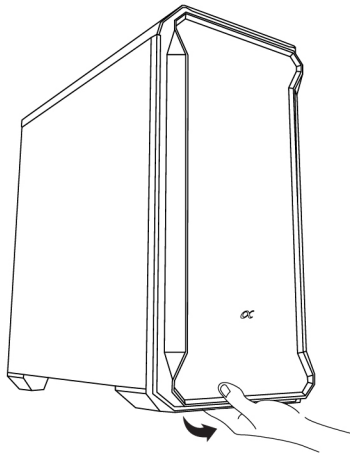

Open the front cover by pulling outwards to the right.

## Front Panel I/O Connections

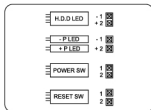

### BUTTONS AND ACTIVITY LIGHTS

---

These cables are connected to the motherboard for the power button ( power sw ), reset button, HDD LED, and power LED ( P+ / P- ).

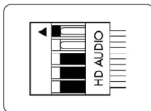

### HD AUDIO

---

This connector attaches to your sound card or motherboard and is used to provide the front panel mic input and headphone output.

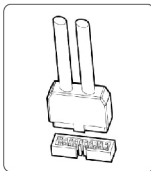







### USB 3.0 CONNECTOR



---

This cable connects to the USB 3.0 header on the motherboard to enable the front USB 3.0 ports.

## Component List

VISUAL	ITEM	QTY	APPLICATION
A 	Motherboard screw	10	Motherboard installation
B 	Motherboard standoff	2	Motherboard installation
C 	SSD screw	8	2.5 hard drive installation
D 	HDD mount screw	8	3.5 hard drive installation
E 	PSU & Rear expansion slot screw	6	Power supply installation Mounting of GPU and other expansion cards
F 	Mounting Nut	1	Installing motherboard standoff

## Component List

VISUAL	ITEM	QTY	APPLICATION
G 	Cable tie	5	Cable management
H 	Rubber Gasket	8	Tempered Glass
I 	Mini Buzzer	1	Pc Computer Motherboard Case Internal Speaker Connector

## Motherboard Installation

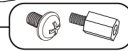
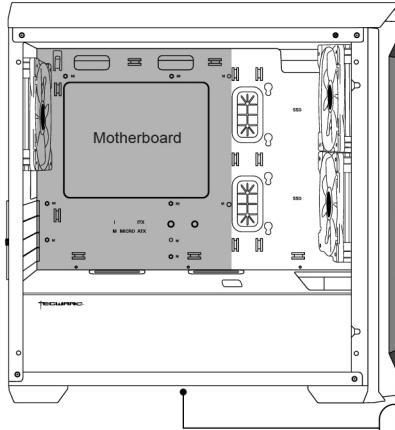

Screw (Type A & B)





## GPU & PSU Installation

Graphics Processing Unit and other expansion cards

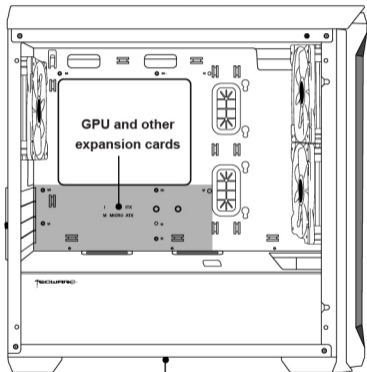

Power Supply Unit Installation

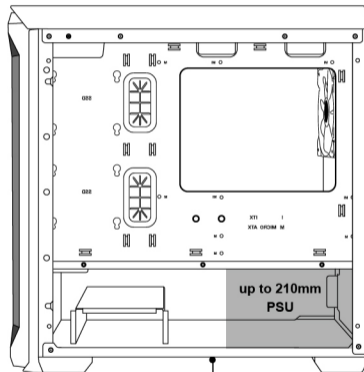

Screw (Type E)

## Cable Management Area

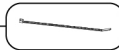
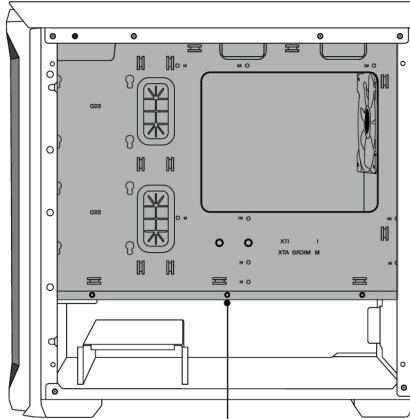

Item (Type G)

## CPU Cooler / Fan Installation

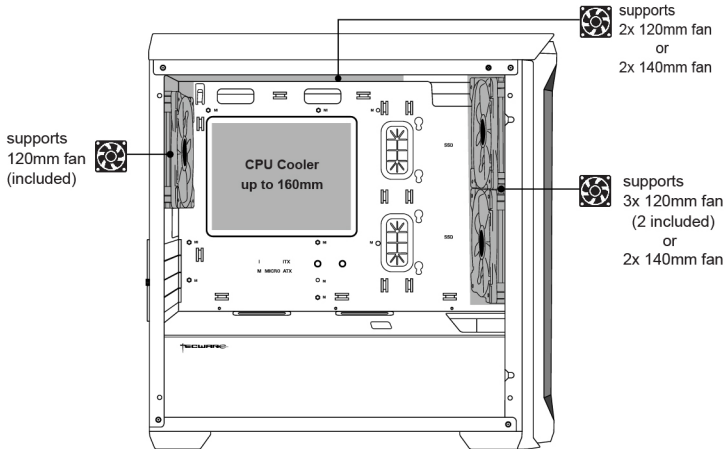

## **Package Contents**

- TECWARE ALPHA M
- Bag of Screws

## **Warranty**

- 1 Year. Please contact your local distributor for support.



TECWARE

[www.tecware.co](http://www.tecware.co)