

TECWARE

α Alpha

Quick Start Guide

Contents

◆ Specification	p.01
◆ Panel Removal	p.02
◆ Front Panel I/O Connections	p.03
◆ Component List	p.04
◆ Motherboard Installations	p.06
◆ SSD Installation	p.07
◆ GPU & PSU Installation	p.08
◆ Cable Management Area	p.09
◆ CPU Cooler / Fan Installation	p.10
◆ Package Contents & Warranty	p.11

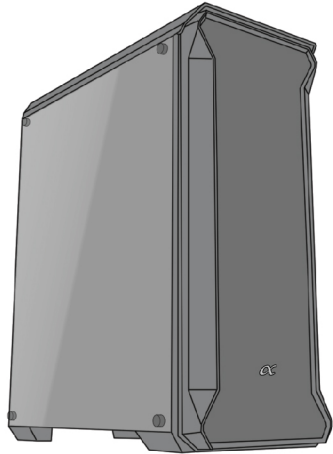

Specifications

Type	Specification
Motherboard Support	E-ATX, ATX, mATX, mITX
Dimensions	447(L) x 220(W) x 510(H) mm
3.5" HDD Drive Bay	2
2.5" SSD Drive Bay	4
Expansion Slots	8
Maximum GPU Length	380mm
Cable Management	29 mm
Maximum CPU Cooler Height	up to 165mm

Panel Removal

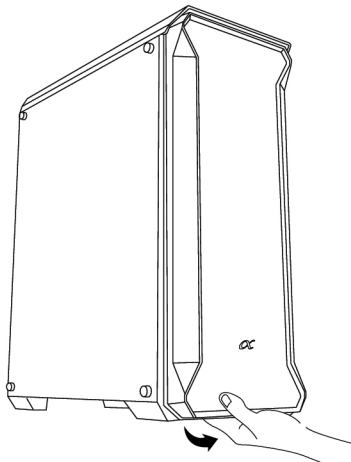

Open the front cover by pulling outwards to the right.

Front Panel I/O Connections

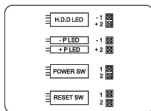

BUTTONS AND ACTIVITY LIGHTS

These cables are connected to the motherboard for the power button (power sw), reset button, HDD LED, and power LED (P+ / P-).

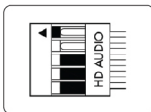

HD AUDIO



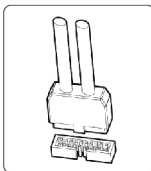



This connector attaches to your sound card or motherboard and is used to provide the front panel mic input and headphone output.





USB 3.0 CONNECTOR

This cable connects to the USB 3.0 header on the motherboard to enable the front USB 3.0 ports.

Component List

VISUAL	ITEM	QTY	APPLICATION
A 	Motherboard & SSD screw	18	Motherboard and 2.5 hard drive installation
B 	Motherboard screw	3	Motherboard installation
C 	Motherboard standoff	3	Motherboard installation
D 	HDD mount screw	8	3.5 hard drive installation
E 	PSU & Rear expansion slot screw	6	Power supply installation Mounting of GPU and other expansion cards
F 	Mounting Nut	1	Installing motherboard standoff

Component List

VISUAL	ITEM	QTY	APPLICATION
G 	Cable tie	5	Cable management
H 	Mini Buzzer	1	Pc Computer Motherboard Case Internal Speaker Connector

Motherboard Installation

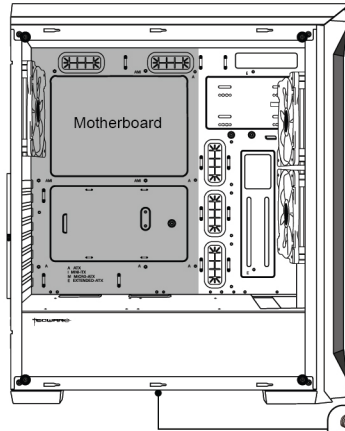

Screw (Type A , B & C)

SSD / HDD Installation

SSD / HDD Drive Installation

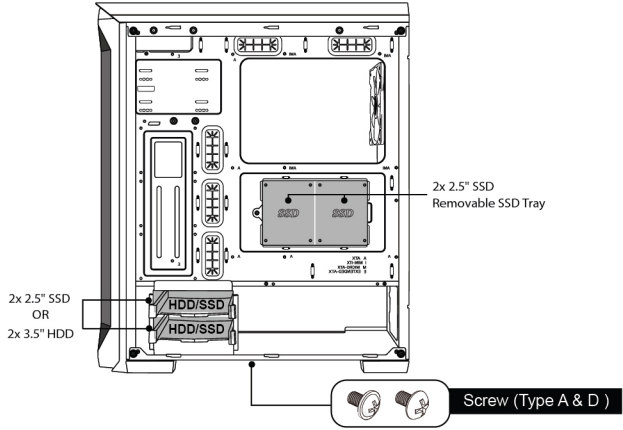

GPU & PSU Installation

Graphics Processing Unit and other expansion cards

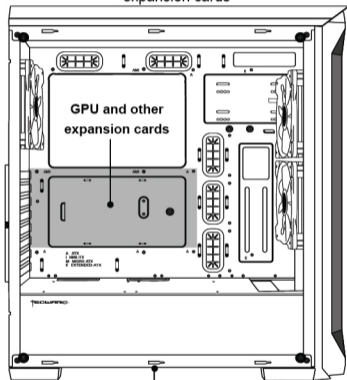

Power Supply Unit Installation

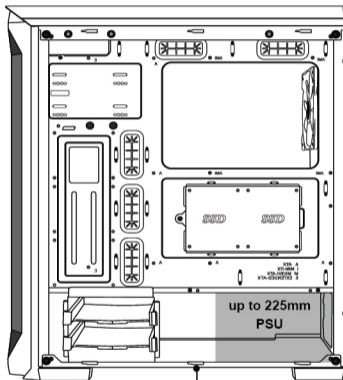

Screw (Type E)

Cable Management Area

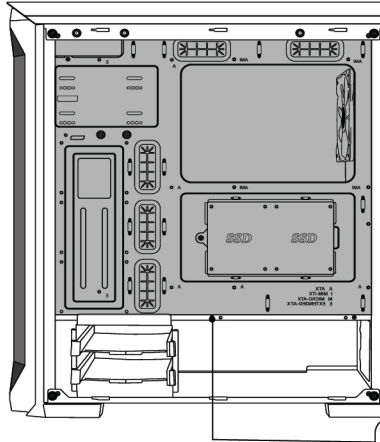

Item (Type G)

CPU Cooler / Fan Installation

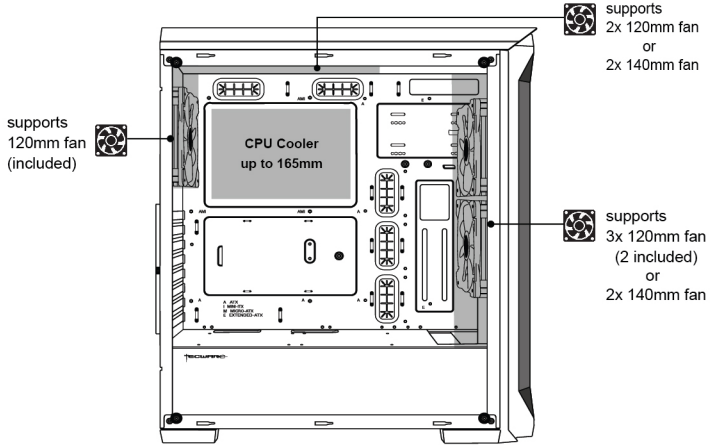

Package Contents

- TECWARE ALPHA TG
- Bag of Screws

Warranty

- 1 Year. Please contact your local distributor for support.



TECWARE

www.tecware.co