

TECWARE

edge AIR

Quick Start Guide

# Contents

◆ Specification .....	p.01
◆ Front Cover .....	p.02
◆ Front Panel I/O Connections .....	p.03
◆ Component List .....	p.04
◆ Motherboard Installations .....	p.05
◆ SSD Installation .....	p.06
◆ GPU & PSU Installation .....	p.07
◆ CPU Cooler / Fan Installation .....	p.08
◆ Package Contents & Warranty .....	p.09

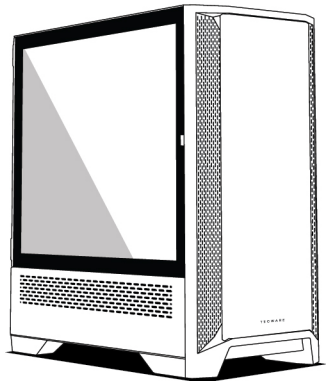

## Specifications

Type	Specification
Motherboard Support	ITX, mATX, ATX
Dimensions	460(L) x 231(W) x 486(H) mm
3.5" HDD Drive Bay	2
2.5" SSD Drive Bay	3
Expansion Slots	7
Maximum GPU Length	380mm
Maximum PSU Length	200mm
Maximum CPU Cooler Height	175mm

## Front Cover

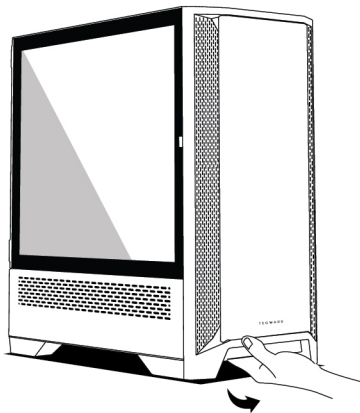

Open the front cover by pulling outwards with controlled force.

## Front Panel I/O Connections

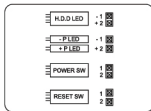

### BUTTONS AND ACTIVITY LIGHTS

---

These cables are connected to the motherboard for the power button ( power sw ), reset button, HDD LED, and power LED ( P+ / P- ).

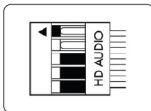

### HD AUDIO

---

This connector attaches to your sound card or motherboard and is used to provide the front panel mic input and headphone output.

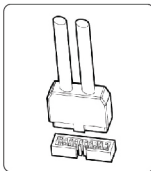







### USB 3.0 CONNECTOR

---

This cable connects to the USB 3.0 header on the motherboard to enable the front USB 3.0 ports.

## Component List

VISUAL	ITEM	QTY	APPLICATION
A 	Motherboard & SSD screw	32	Motherboard and 2.5/3.5 hard drive installation
B 	Motherboard standoff	6	Motherboard installation
C 	Thumb screw	2	Rear Panel/Expansion Slots
D 	PSU & Rear expansion slot screw	14	Power supply installation Mounting of GPU and other expansion cards
E 	Radiator Screw	8	Radiator Installation
F 	Cable Tie	6	Cable management

## Motherboard Installation

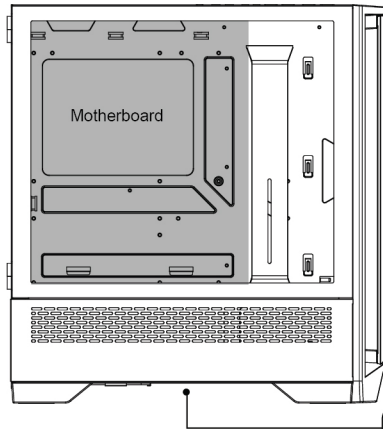

Screw Type A & B

## SSD Installation

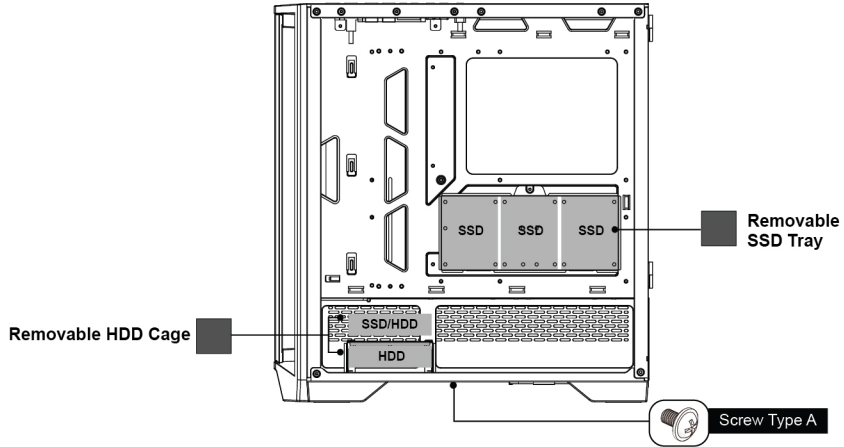



# GPU & PSU Installation

Graphics Processing Unit and other expansion cards

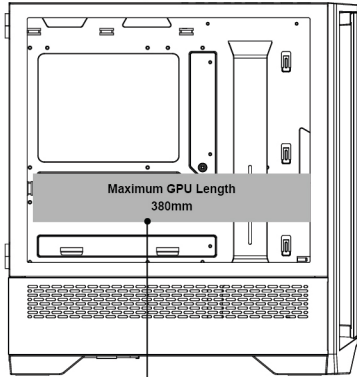

Maximum GPU Length  
380mm

Power Supply Unit Installation

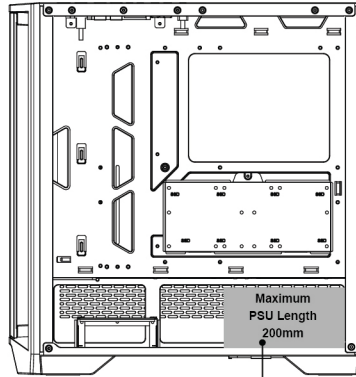

Maximum  
PSU Length  
200mm



Screw (Type D)

## CPU Cooler / Fan & Radiator Installation

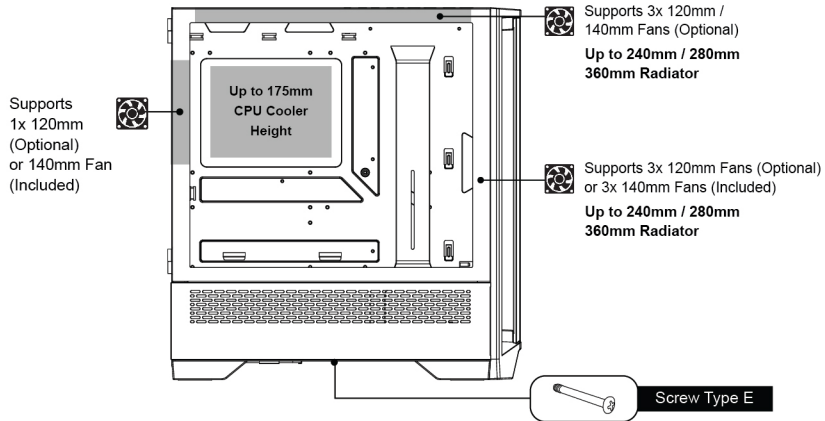

## **Package Contents**

- 1 x TECWARE Edge Air Case
- 1 x Accessories Box

## **Warranty**

- 1 Year. Please contact your local distributor for support.

T E C W A R E

[www.tecware.co](http://www.tecware.co)