

TECWARE

M2

MICRO**ATX**

Quick Start Guide

Contents

◆ Specification	p.01
◆ Panel Removal	p.02
◆ Front Panel I/O Connections	p.03
◆ Component List	p.04
◆ Motherboard Installations	p.05
◆ SSD Installation	p.06
◆ GPU & PSU Installation	p.07
◆ Cable Management Area	p.08
◆ CPU Cooler / Fan Installation	p.09
◆ Package Contents & Warranty	p.10

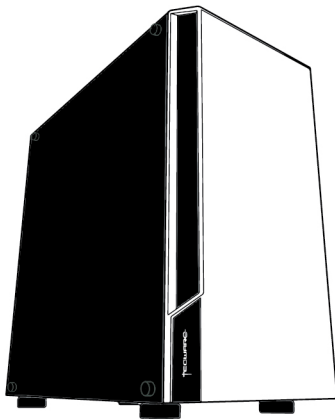

Specifications

Type	Specification
Motherboard Support	Micro-ATX / Mini TX
Dimensions	415(L) x 212(W) x 395(H) mm
3.5" HDD Drive Bay	2
2.5" SSD Drive Bay	2
Expansion Slots	4
Maximum GPU Length	350mm
Cable Management	20 mm
Maximum CPU Cooler Height	up to 160mm

Panel Removal

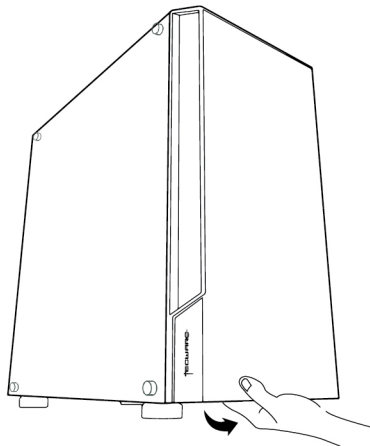

Open the front cover by pulling outwards to the right.

Front Panel I/O Connections

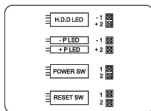

BUTTONS AND ACTIVITY LIGHTS

These cables are connected to the motherboard for the power button (power sw), reset button, HDD LED, and power LED (P+ / P-).

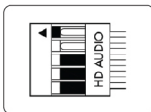

HD AUDIO



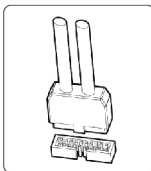



This connector attaches to your sound card or motherboard and is used to provide the front panel mic input and headphone output.



USB 3.0 CONNECTOR

This cable connects to the USB 3.0 header on the motherboard to enable the front USB 3.0 ports.

Component List

VISUAL	ITEM	QTY	APPLICATION
A 	Motherboard & SSD screw	18	Motherboard and 2.5 hard drive installation
B 	Motherboard standoff	3	Motherboard installation
C 	HDD mount screw	4	3.5 hard drive installation
D 	Thumb screw	4	Rear Panel/Expansion Slots
E 	PSU & Rear expansion slot screw	6	Power supply installation Mounting of GPU and other expansion cards
F 	Radiator Fan Screw	4	Radiator/Fan Installation
G 	Rubber Gasket	4	Tempered Glass

Motherboard Installation

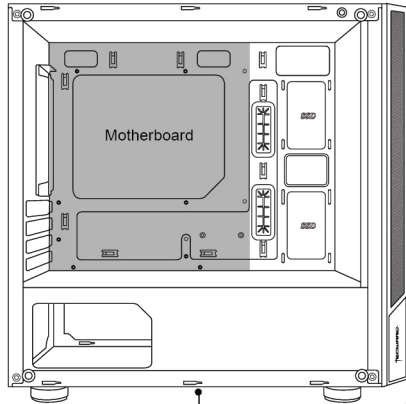

SSD / HDD Installation

SSD / HDD Drive Installation

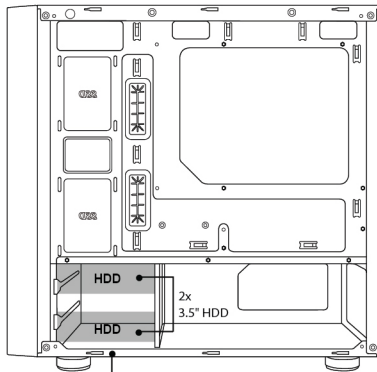
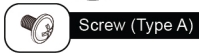
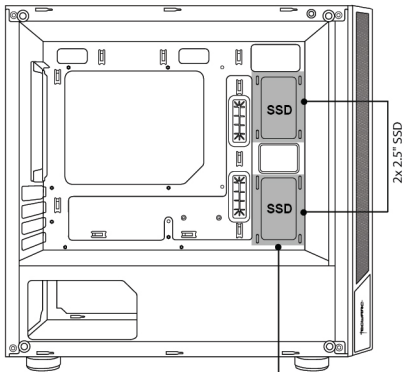

GPU & PSU Installation

Graphics Processing Unit and other expansion cards

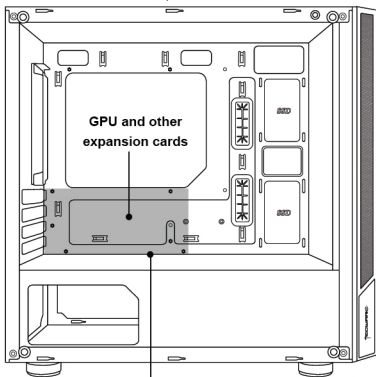

Power Supply Unit Installation

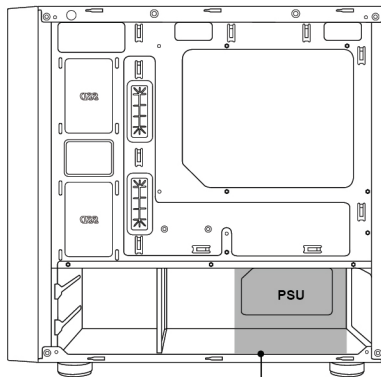

Screw (Type E)

Cable Management Area

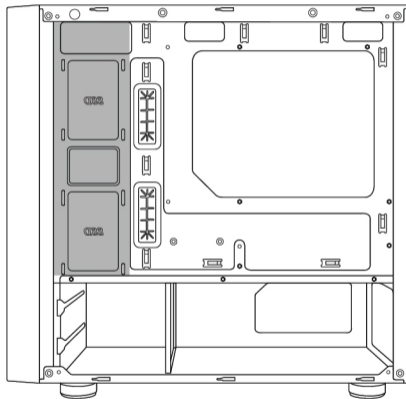

CPU Cooler / Fan Installation

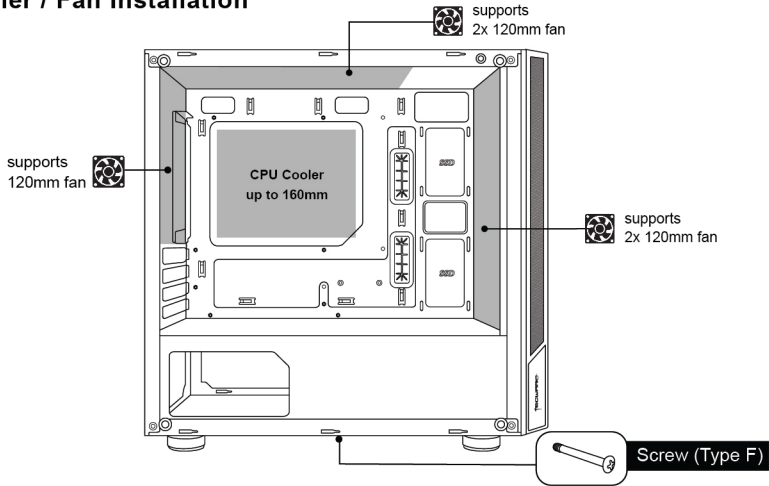

Package Contents

- TECWARE M2 MICRO ATX
- Bag of Screws

Warranty

- 1 Year. Please contact your local distributor for support.

The logo for TECWARE features the word "TECWARE" in a bold, white, sans-serif font. The letter 'T' is stylized with a vertical line extending downwards from its base. The letter 'E' has a horizontal line extending to the right from its top bar. The background is a dark, abstract geometric pattern of overlapping planes and lines, creating a sense of depth and perspective.

TECWARE

www.tecware.co