

TECWARE

VXL

EVO

ATX DUAL TEMPERED GLASS CASE

Quick Start Guide

# Contents

◆ Specification .....	p.01
◆ Panel Removal .....	p.02
◆ Front Panel I/O Connections .....	p.03
◆ Component List .....	p.04
◆ Motherboard Installations .....	p.05
◆ SSD / HDD Installation .....	p.06
◆ GPU & PSU Installation .....	p.07
◆ CPU Cooler / Fan Installation .....	p.08
◆ Package Contents & Warranty .....	p.09

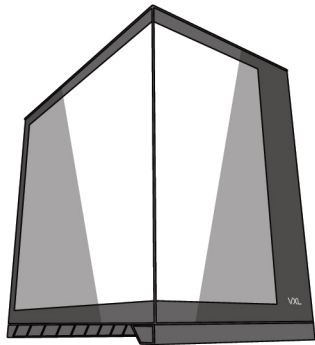

## Specifications

Type	Specification
Motherboard Support	ATX, mATX, ITX
Dimensions	445(L) x 285(W) x 430(H)mm
3.5" HDD Drive Bay	2
2.5" SSD Drive Bay	3
Expansion Slots	7
Maximum GPU Length	390mm
Maximum CPU Cooler Height	160mm
Maximum PSU Length	200mm

## Panel Removal

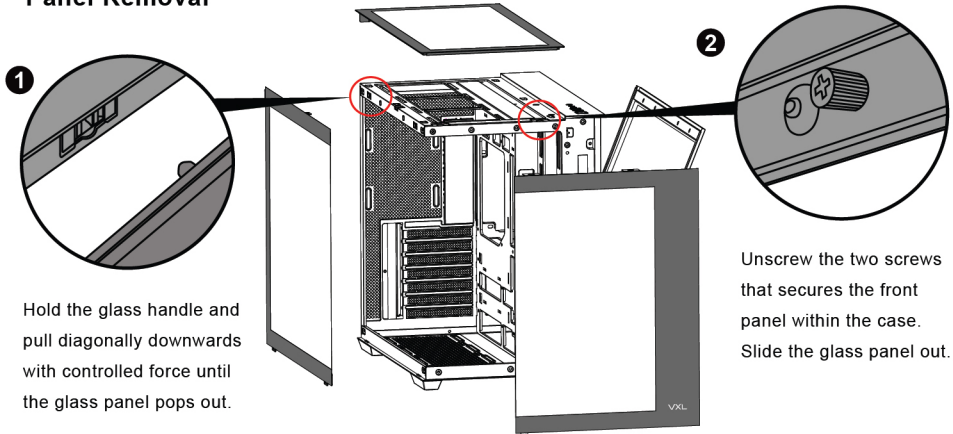

Hold the glass handle and pull diagonally downwards with controlled force until the glass panel pops out.

Unscrew the two screws that secures the front panel within the case. Slide the glass panel out.

*\*Important note: Please remove the side glass panel first before attempting to remove front glass panel.*

## Front Panel I/O Connections

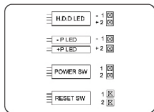

### BUTTONS AND ACTIVITY LIGHTS

---

These cables are connected to the motherboard for the power button ( power sw ), reset button, HDD LED, and power LED ( P+ / P- ).

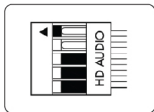

### HD AUDIO

---

This connector attaches to your sound card or motherboard and is used to provide the front panel mic input and headphone output.

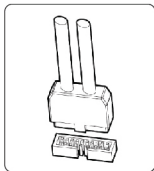







### USB 3.0 CONNECTOR

---

This cable connects to the USB 3.0 header on the motherboard to enable the front USB 3.0 ports.

## Component List

VISUAL	ITEM	QTY	APPLICATION
A 	Motherboard & SSD screw	23	Motherboard and 2.5 hard drive installation
B 	Motherboard standoff	4	Motherboard installation
C 	HDD mount screw	8	3.5 hard drive installation
D 	PSU & Rear expansion slot screw	7	Power supply installation Mounting of GPU and other expansion cards
E 	Cable tie	6	Cable management
F 	Velcro Cable Fasteners	3	Cable management

## Motherboard Installation

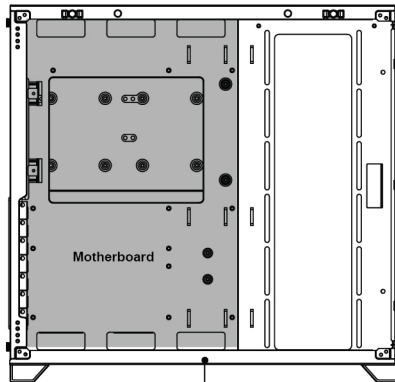

Screw Type A & B

## SSD / HDD Installation

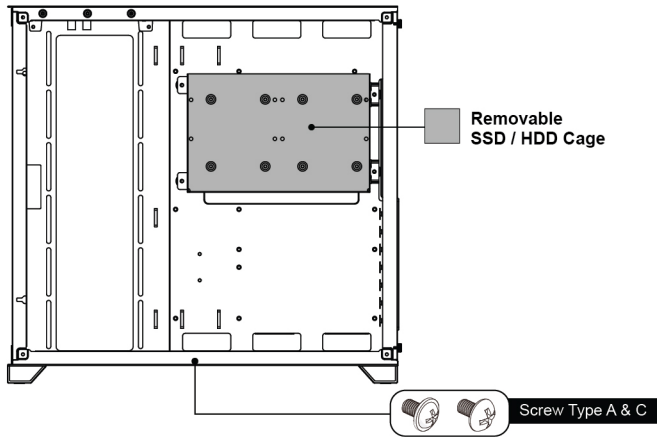



# GPU & PSU Installation

Graphics Processing Unit and other expansion cards

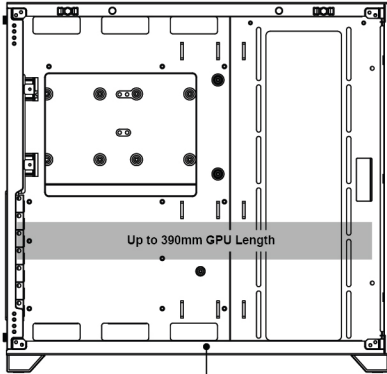

Power Supply Unit Installation

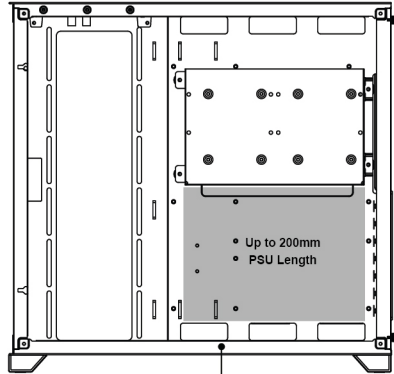

Screw (Type D)

## CPU Cooler / Fan Installation

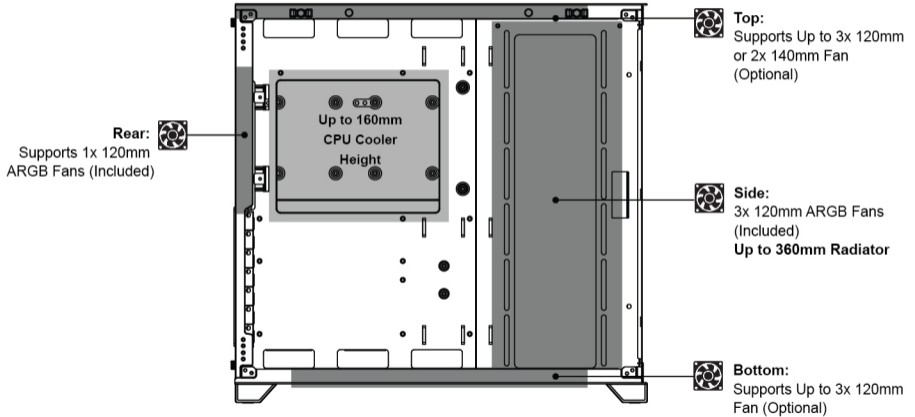

## **Package Contents**

- 1 x TECWARE VXL EVO Case
- 1 x Bag of Accessories

## **Warranty**

- 1 Year. Please contact your local distributor for support.

T E C W A R E

[www.tecware.co](http://www.tecware.co)